

# S3871 Series Solid State Power Amplifier

## User Manual



## The document applies to following models:

- S3871x series Power Amplifier (9kHz - 60GHz)

## Standard Pack:

- 1x Main Machine
- 1x Power Cord
- 1x U Disk (for documents)

## Ordering Information:

### Main machine

- S3871AD Power Amplifier: 9kHz - 250MHz, 54dB
- S3871AE Power Amplifier: 9kHz - 250MHz, 56dB
- S3871AH Power Amplifier: 80MHz - 1GHz, 54dB
- S3871AK Power Amplifier: 80MHz - 1GHz, 56dB
- S3871AA Power Amplifier: 1GHz - 2.5GHz, 53dB
- S3871AP Power Amplifier: 1GHz - 2.5GHz, 55dB
- S3871AB Power Amplifier: 1GHz - 6GHz, 48dB
- S3871AQ Power Amplifier: 2GHz - 6GHz, 53dB
- S3871AR Power Amplifier: 2GHz - 6GHz, 56dB
- S3871AS Power Amplifier: 500MHz - 6GHz, 50dB
- S3871AT Power Amplifier: 500MHz - 6GHz, 53dB
- S3871AU Power Amplifier: 500MHz - 6GHz, 56dB
- S3871DA Power Amplifier: 6GHz - 18GHz, 46dB
- S3871DB Power Amplifier: 6GHz - 18GHz, 50dB
- S3871DC Power Amplifier: 6GHz - 18GHz, 53dB
- S3871DD Power Amplifier: 6GHz - 18GHz, 56dB
- S3871DE Power Amplifier: 2GHz - 18GHz, 53dB

- S3871DK Power Amplifier: 2GHz - 18GHz, 50dB
- S3871DH Power Amplifier: 2GHz - 18GHz, 46dB
- S3871EA Power Amplifier: 18GHz - 26.5GHz, 43dB
- S3871EB Power Amplifier: 18GHz - 26.5GHz, 46dB
- S3871EC Power Amplifier: 18GHz - 26.5GHz, 53dB
- S3871FA Power Amplifier: 26GHz - 32GHz, 43dB
- S3871FB Power Amplifier: 32GHz - 40GHz, 43dB
- S3871FC Power Amplifier: 24GHz - 30GHz, 46dB
- S3871FN Power Amplifier: 33GHz - 37GHz, 45dB
- S3871FD Power Amplifier: 37GHz - 43GHz, 46dB
- S3871FE Power Amplifier: 26GHz - 40GHz, 43dB
- S3871FF Power Amplifier: 26GHz - 40GHz, 49dB
- S3871FG Power Amplifier: 26GHz - 40GHz, 53dB
- S3871FP Power Amplifier: 18GHz - 40GHz, 46dB
- S3871FQ Power Amplifier: 18GHz - 40GHz, 50dB
- S3871FR Power Amplifier: 18GHz - 40GHz, 53dB
- S3871FS Power Amplifier: 2GHz - 40GHz, 40dB
- S3871HA Power Amplifier: 40GHz - 47GHz, 40dB
- S3871LA Power Amplifier: 40GHz - 60GHz, 36dB

### **Options**

- S3871AB-020: 500MHz - 6GHz, 20W
- S3871AB-040: 500MHz - 6GHz, 40W
- S3871AS-060: 500MHz - 6GHz, 60W
- S3871AS-080: 500MHz - 6GHz, 80W
- S3871AT-150: 500MHz - 6GHz, 150W
- S3871AT-200: 800MHz - 4.2GHz, 200W
- S3871AT-250: 800MHz - 3GHz, 250W
- S3871AT-300: 2.1GHz - 2.7GHz, 300W
- S3871AU-250: 500MHz - 6GHz, 250W

- S3871AU-300: 500MHz - 3GHz, 300W
- S3871AU-350: 500MHz - 3GHz, 350W
- S3871AU-400: 500MHz - 3GHz, 400W
- S3871AU-450: 500MHz - 3GHz, 450W
- S3871AU-3001: 800MHz - 4.2GHz, 300W
- S3871AU-4001: 800MHz - 4.2GHz, 400W
- S3871AU-500: 2.1GHz - 2.7GHz, 500W
- S3871DA-040: 6GHz - 18GHz, 40W
- S3871DB-060: 6GHz - 18GHz, 60W
- S3871DB-080: 6GHz - 18GHz, 80W
- S3871DC-150: 6GHz - 18GHz, 150W
- S3871DH-005: 2GHz - 18GHz, 5W
- S3871DH-010: 2GHz - 18GHz, 10W
- S3871DK-080: 2GHz - 18GHz, 80W
- S3871EB-040: 18GHz - 26.5GHz, 40W
- S3871EB-060: 18GHz - 26.5GHz, 60W
- S3871EB-080: 18GHz - 26.5GHz, 80W
- S3871EC-120: 18GHz - 26.5GHz, 120W
- S3871EC-150: 18GHz - 26.5GHz, 150W
- S3871EC-200: 18GHz - 26.5GHz, 200W
- S3871FN-050: 33GHz - 37GHz, 50W
- S3871FE-020: 26GHz - 40GHz, 20W
- S3871FF-060: 26GHz - 40GHz, 60W
- S3871FF-080: 26GHz - 40GHz, 80W
- S3871FG-150: 26GHz - 40GHz, 150W
- S3871FP-005: 18GHz - 40GHz, 5W
- S3871FP-010: 18GHz - 40GHz, 10W
- S3871FQ-060: 18GHz - 40GHz, 60W
- S3871FQ-080: 18GHz - 40GHz, 80W
- S3871LA-005: 40GHz - 60GHz, 5W

## **Preface**

Thank you for choosing Saluki Technology Products.

We devote ourselves to meeting your demands, providing you high-quality measuring instrument and the best after-sales service. We persist with “superior quality and considerate service”, and are committed to offering satisfactory products and service for our clients.

## **Document No.**

S3871-03-01

## **Version**

Rev01 2020.10

## **Document Authorization**

The information contained in this document is subject to change without notice. The power to interpret the contents of and terms used in this document rests with Saluki.

Saluki Tech owns the copyright of this document which should not be modified or tampered by any organization or individual or reproduced or transmitted for the purpose of making profit without its prior permission, otherwise Saluki will reserve the right to investigate and affix legal liability of infringement.

## **Product Quality Assurance**

The warranty period of the product is 36 months from the date of delivery. The instrument manufacturer will repair or replace damaged parts according to the actual situation within the warranty period.

## **Product Quality Certificate**

The product meets the indicator requirements of the document at the time of delivery. Calibration and measurement are completed by the measuring organization with qualifications specified by the state, and relevant data are provided for reference.

## **Quality/Settings Management**

Research, development, manufacturing and testing of the product comply with the requirements of the quality and environmental management system.

## Contacts

Service Tel: +886. 909 602 109

Address: No. 367 Fuxing N Road, Taipei 105, Taiwan (R.O.C.)

## Contents

Chapter 1	Overview.....	8
Chapter 2	Unpacking.....	9
Chapter 3	Operation Guide.....	11
3.1	Front Panel Features.....	12
3.2	Rear Panel Features.....	13
Chapter 4	Working Principle.....	14
Chapter 5	Technical Specifications and Indicator Tests.....	15
5.1	Main Indicators and Performance Characteristics.....	15
5.2	Indicator Tests.....	18
Chapter 6	Maintenance and Repair.....	22
6.1	Regular Maintenance.....	22
6.2	General Maintenance.....	22

## Chapter 1 Overview

The S3871 series solid-state power amplifiers are a new series of microwave and millimeter-wave amplifiers. This series is easy to carry and operate. Its most prominent characteristics are wide band, high gain and high power. This series consists of multiple amplifiers operating in different frequency bands. Please refer to Chapter 5 Technical Indicators for their models and corresponding operating frequencies.

The S3871 series solid-state power amplifiers are an important component in many fields such as high-power test systems, microwave and millimeter-wave communications systems and electromagnetic compatibility test. They are test instruments developed and produced to solve such problems of current microwave and millimeter-wave general signal sources as low output power and inability to meet the needs of high-power signals.

The S3871 series solid-state power amplifiers focus on breaking through the amplification and synthesis technologies of broadband high-power signals, and are planned to be used in the development, manufacturing, maintenance and support of electronic weapons and equipment of our army like radars, satellites, broadband communications and electronic countermeasures. As universal high-performance, broadband high-power amplifiers, they can also be widely used in many fields like electromagnetic compatibility testing, high-power electric vacuum device testing, non-linear testing of high-power components and so on. As indispensable important instruments in broadband high-power testing systems, they have a broad prospect in the application of electronic measurement in the military field.

This manual introduces the applications, performance characteristics, basic working principles, operation and other information of S3871 series solid-state power amplifiers, helping you to familiarize yourself with and master the operation methods and key points of the instruments as soon as possible. Please read this manual carefully and follow its instructions for correct operation.

This manual consists of 6 chapters.

- ✧ Chapter 1 introduces the features and applications of S3871 series solid-state power amplifiers
- ✧ Chapter 2 introduces the unpacking inspection and pre-operation precautions of S3871 series solid-state power amplifiers.
- ✧ Chapter 3 introduces the front/rear panel features and operation instructions of S3871 series solid-state power amplifiers.
- ✧ Chapter 4 introduces the basic working principles of S3871 series solid-state power amplifiers.
- ✧ Chapter 5 introduces major technical indicators and performance characteristic of S3871 series solid-state power amplifiers and offers details about test methods of the instrument indicators.
- ✧ Chapter 6 introduces the maintenance and simple repair of S3871 series solid-state power amplifiers.

We sincerely hope that SALUKI can help you work more conveniently and efficiently. If you have any question during the use of the instruments, please do not hesitate to contact us.



## Chapter 2 Unpacking

### 1. Model confirmation

When you open the package, you will see the following items:

- ✧ 1x Main Machine
- ✧ 1x Power Cord
- ✧ 1x U Disk (for documents)

Please check carefully for any incorrect or missing items against the order contract and the packing list. If there is any problem, please contact our operation center according to the contact information in the preface, and we will solve it as soon as possible.

### 2. Visual examination

Check the instrument carefully for any damage during transportation. It is strictly prohibited to switch on the instrument if any obvious damage to the instrument is found. Please contact our operation center according to the contact information in the preface. We will repair or replace the product accordingly as soon as possible.

### 3. Operating environment

Please refer to the environmental adaptability part in Technical Indicators section of this manual. And please pay special attention to the following requirements:

Power supply: 220V ( $\pm 10\%$ ), 50Hz ( $\pm 5\%$ )

Power socket: 3-core power socket must be used, and grounding is strictly required.

Power cable of the instrument: 3-core power cable provided in the package

For the safety of users, anti-static accessories must be provided with at least  $1M\Omega$  isolation resistance from ground.



Before connecting the solid-state power amplifier to the power supply, please check carefully whether the supply voltage is normal and whether the connector at the output end of the amplifier is connected with a high-power load, otherwise it is very likely to cause damage to the instrument!

---

### 4. Electrostatic protection

Static electricity is extremely destructive to electronic components and instruments. The required anti-static measures must be completed on an anti-static workbench. Usually we take two anti-static measures: conductive table mat and wrist strap, conductive floor mat and ankle strap. For the safety of users, anti-static accessories must be provided with at least  $1M\Omega$  isolation resistance from ground.

Please correctly apply the following anti-static measures to reduce electrostatic damage: ensure correct grounding of all instruments prevent the generation of static electricity; operators must wear anti-static wrist straps before touching the connectors, the core wire or before any assembly operation.

---



The above-mentioned anti-static measures cannot be applied when the voltage exceeds 500V!

---

## Chapter 3 Operation Guide

The S3871 series solid-state power amplifiers cover a frequency range of 1GHz - 60GHz and a unit output power range of 1W - 100W. Adopting the most advanced broadband space power synthesis technology in the world at present, they have completely independent intellectual property rights and adopt the external structure as standard bench top instruments.

The interface is simple and user-friendly, allowing for simple and convenient operation. The panel consists of five parts, namely, RF input port, RF output port, function setting keys, gain regulator and power display interface. The function setting keys are used to set different working states of the power amplifier, and the gain regulator is used to set the gain and output power of the power amplifier. The display interface is divided into two parts, one for working status and the other for function settings. The working state display interface can display the output power and incident power. The current working frequency is shown on the top of the display and the status bar, located on the bottom of the display, shows whether the current work is in a local state or in a remote-control state, in an open loop state or in a stable amplitude state. The instrument can display the output power as well as the two working states of open loop and internal amplitude stabilization. In the open loop state, adjusting the gain regulator allows you to realize different output powers and gains.

In terms of protective design, the instrument features many alarm and protection functions. Firstly, the instrument offers air-cooling alarm and protection, over-temperature alarm and protection, mismatch alarm and protection. The thresholds of over-temperature alarm and mismatch alarm can be flexibly set as required by users. When an alarm is generated, you can also take different countermeasures, such as minimizing the gain or cutting off the RF. Another protection of the instrument is the working state locking function. When the working state is set to locked, the current gain and output power will not be changed even if the gain regulator is turned. This function can effectively prevent power change caused by incorrect operation or carelessness of users, thus ensuring the safety of the measured piece.

As for humanized design, first of all, the RF input port and RF output port are provided separately on the left and right sides of the front panel to facilitate users to connect cables or measured pieces. Secondly, the display interface displays not only the output power, but also the incident power. The display units are W and dBm respectively. In addition, you can also choose to the display only the output power and not the incident power.

The instrument also has the following features: working state selectable between open-loop and internal stable amplitude, working state selectable between local and remote control, working interface selectable between Chinese and English, selectable alarm processing modes and selectable adjustment direction for the gain regulator. Such features increase users' selectivity to the working state, meet different demands of users, and improve the convenience of use.

### 3.1 Front Panel Features

S3871 series solid-state power amplifiers adopt concise and clear front panel design. According to different working frequency bands and output powers, this series of products adopt different dimensions and front and rear panels, which, however, do not affect the use by users. Let's take 3871DC as an example. The configuration diagram of its front panel is shown in Figure 3-1.



Figure 3-1 Front panel of S3871 series solid-state power amplifiers

#### 1. Output Power display window

S3871 series solid-state power amplifiers are equipped with LCD displays on the front panels, achieving display of the output powers of amplifiers.

#### 2. RF Input connector

The RF input connector is used for inputting the RF input signals of the solid-state power amplifier.

#### 3. RF Output connector

The RF output connector is used for outputting the RF output signals of the solid-state power amplifier.

#### 4. Gain (Power) Regulator

S3871 series solid-state power amplifiers are equipped with the Gain (Power) regulators on the front panels, allowing for adjustment of the gains or output powers of the amplifiers as required.

#### 5. Setting Wizard

S3871 series solid-state power amplifiers are equipped with Setting Wizard keys on the front panels, allowing users to set the frequency displayed on the screen to the actual working frequency so as to achieve the frequency compensation of power display and thus ensuring more accurate power display. The operation is as follows: firstly, press the "OK" key, and the frequency selection interface will appear on the screen, then set the display frequency to the current working frequency of the amplifier with the navigation keys, and then press the "OK" key again.

#### 6. Alarm indicator

S3871 series solid-state power amplifiers are equipped indication for mismatch, over-temperature and air-cooling alarms, realizing warning for mismatch of the output port, excessive temperature inside the amplifier and abnormal operation of the air cooling fans.

## 7. Operation switch

The operation switches are used to control the standby and working states of the solid-state power amplifier. After turning on the power switch on the rear panel, the working switch of the front panel is in the standby state by default and will be switched to the working state after pressing the key.

### 3.2 Rear Panel Features

The configuration of the rear panel of S3871 series solid-state power amplifiers is shown in Figure 3-2.



Figure 3-2 Rear panel of S3871 series solid-state power amplifiers

#### 1. Power switch

When the power switch, located on the rear panel, is turned on, the instrument is powered on and in the standby status.

#### 2. AC power input

This connector is used to input AC voltage of  $220V \pm 10\%$  and 50Hz.

#### 3. Ethernet port

At present, S3871 series solid-state power amplifiers support remote power control through the Ethernet port at the upper right corner of the rear panel.

## Chapter 4 Working Principle

The solid-state power amplifier amplifies the input signal power to generate the output signal power, the power supply module provides the DC voltage required by the S3871 series solid-state power amplifier, the bias plate provides the bias voltage for the solid-state power amplifier, and the power measurement unit converts the coupled detection output voltage signal from the solid-state power amplifier into RF output power displayed in dBms and Watts on the LCD screen of the front panel. The schematic diagram of the amplifiers is shown in Figure 4-1.

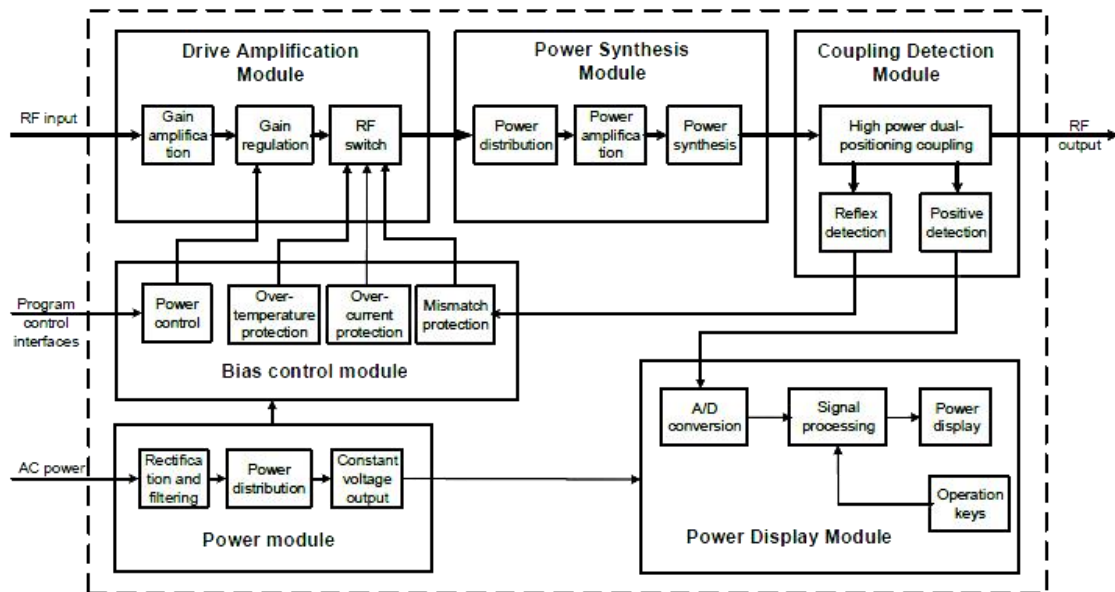

Figure 4-1 Schematic diagram for amplifiers of S3871 series solid-state power amplifiers

The S3871 series solid-state power amplifiers adopt two working modes as shown below:

### 1. Open-loop working mode

With the Setting Wizard keys on the front panel of the instrument, the working state can be set to "Open Loop". At this time, microwave signals are input from the RF frequency input end of the amplifier, then amplified by the amplifier and then output through the main loop of the directional coupler. A part of the output power is sent to a detector through coupling of a directional coupler, which converts the microwave signals into a voltage signals for processing, and finally the actual output power value is displayed on the front panel.

### 2. Internal amplitude stabilization working mode

With the Setting Wizard keys on the front panel of the instrument, the working state can be set to "Internal Amplitude Stabilization". At this time, the coupling port of the directional coupler in the output path sends the output coupling signals to the detector and converts it into detection voltage, which, after amplification, is sent to the internal amplitude stabilization loop inside the amplifier. The internal amplitude stabilization mode can improve the flatness of the output power.

## Chapter 5 Technical Specifications and Indicator Tests

### 5.1 Main Indicators and Performance Characteristics

#### 1. Technical indicators of S3871 series solid-state power amplifiers

(1) Different models and main technical indicators are shown in the table below:

Model	Frequency Band	Gain (dB)	Psat (dBm)	Input Port	Output Port
S3871AD	9kHz - 250MHz	54	51	N(f)	N(f)
S3871AE	9kHz - 250MHz	56	53	N(f)	N(f)
S3871AH	80MHz - 1GHz	54	51	N(f)	N(f)
S3871AK	80MHz - 1GHz	56	53	N(f)	N(f)
S3871AA	1GHz - 2.5GHz	53	50	N(f)	N(f)
S3871AP	1GHz - 2.5GHz	55	52	N(f)	N(f)
S3871AB	1GHz - 6GHz	48	45	N(f)	N(f)
S3871AQ	2GHz - 6GHz	53	50	N(f)	N(f)
S3871AR	2GHz - 6GHz	56	53	N(f)	N(f)
S3871AS	500MHz - 6GHz	50	47	N(f)	N(f)
S3871AT	500MHz - 6GHz	53	50	N(f)	N(f)
S3871AU	500MHz - 6GHz	56	53	N(f)	N(f)
S3871DA	6GHz - 18GHz	46	43	N(f)	N(f)
S3871DB	6GHz - 18GHz	50	47	N(f)	N(f)
S3871DC	6GHz - 18GHz	53	50	N(f)	N(f)
S3871DD	6GHz - 18GHz	56	53	N(f)	N(f)
S3871DE	2GHz - 18GHz	53	50	N(f)	N(f)
S3871DK	6GHz - 18GHz	50	47	N(f)	N(f)
S3871DH	2GHz - 18GHz	46	43	N(f)	N(f)
S3871EA	18GHz - 26.5GHz	43	40	3.5mm(m)	3.5mm(m)
S3871EB	18GHz - 26.5GHz	46	43	3.5mm(m)	3.5mm(m)

S3871EC	18GHz - 26.5GHz	53	50	3.5mm(m)	WR42
S3871FA	26GHz - 32GHz	43	40	2.4mm(m)	2.4mm(m)
S3871FB	32GHz - 40GHz	43	40	2.4mm(m)	2.4mm(m)
S3871FC	24GHz - 30GHz	46	43	2.4mm(m)	2.4mm(m)
S3871FN	33GHz - 37GHz	45	45	2.4mm(m)	WR28
S3871FD	37GHz - 43GHz	46	43	2.4mm(m)	2.4mm(m)
S3871FE	26GHz - 40GHz	43	40	2.4mm(m)	2.4mm(m)
S3871FF	26GHz - 40GHz	49	46	2.4mm(m)	WR28
S3871FG	26GHz - 40GHz	53	50	2.4mm(m)	WR28
S3871FP	18GHz - 40GHz	46	43	2.4mm(m)	24JS18000
S3871FQ	18GHz - 40GHz	50	47	2.4mm(m)	24JS18000
S3871FR	18GHz - 40GHz	53	50	2.4mm(m)	24JS18000
S3871FS	2GHz - 40GHz	40	37	2.4mm(m)	2.4mm(m)
S3871HA	40GHz - 47GHz	40	37	2.4mm(m)	2.4mm(m)
S3871LA	40GHz - 60GHz	36	33	1.85mm(m)	1.85mm(m)

(2) Typical curve for constant-temperature output power of S3871 series solid-state power amplifiers (for reference only):

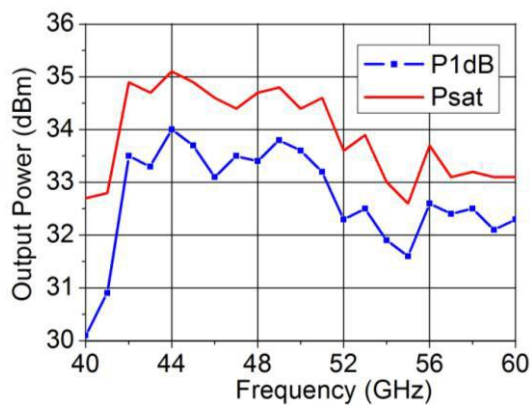

S3871LA Output power VS Frequency

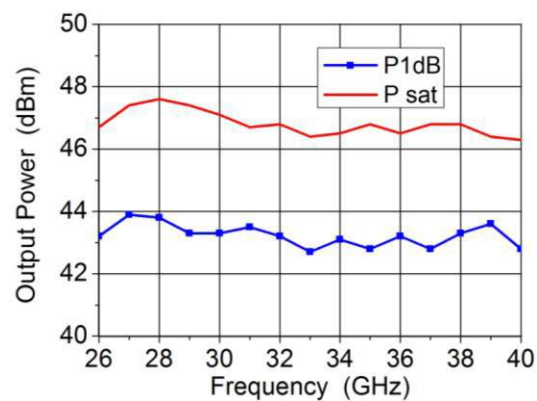

S3871FF Output power VS Frequency



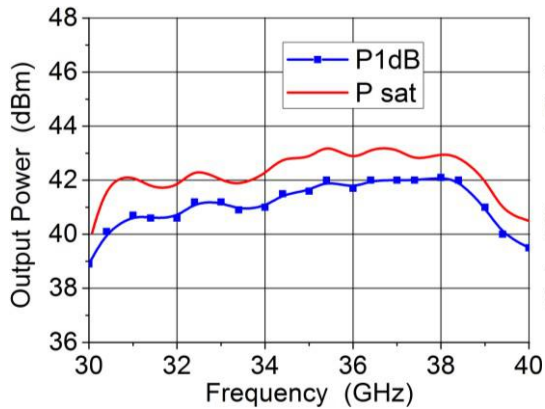

S3871FB Output power VS Frequency

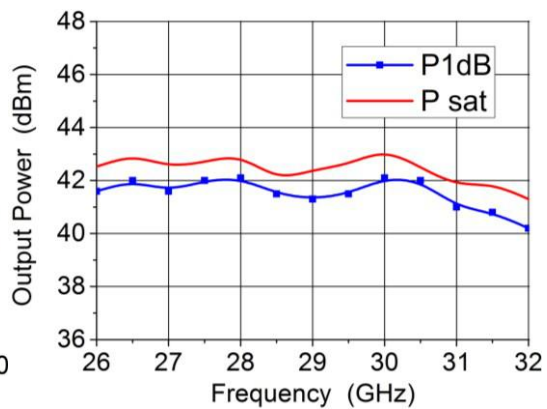

S3871FA Output power VS Frequency

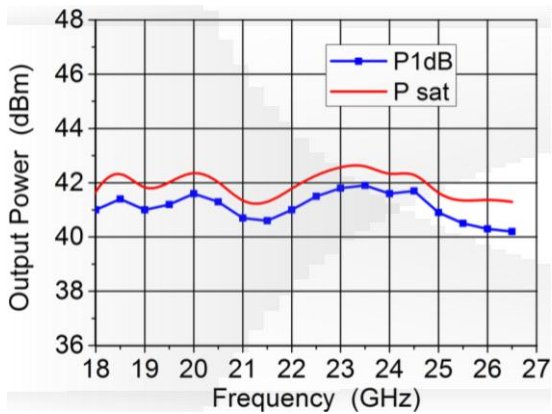

S3871EA Output power VS Frequency

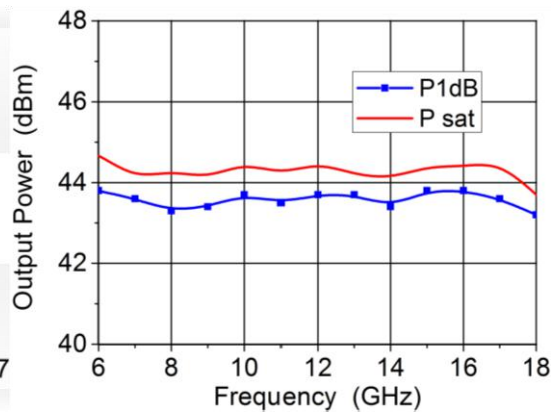

S3871DA Output power VS Frequency

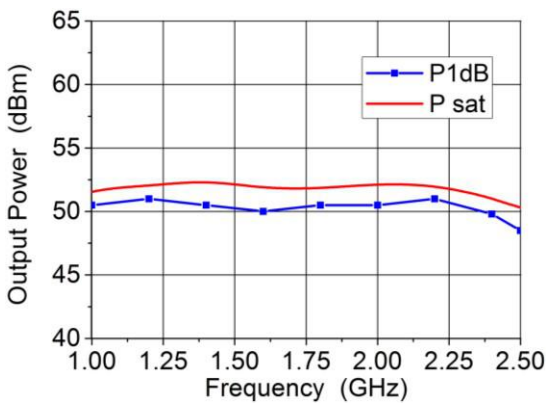

S3871AA Output power VS Frequency

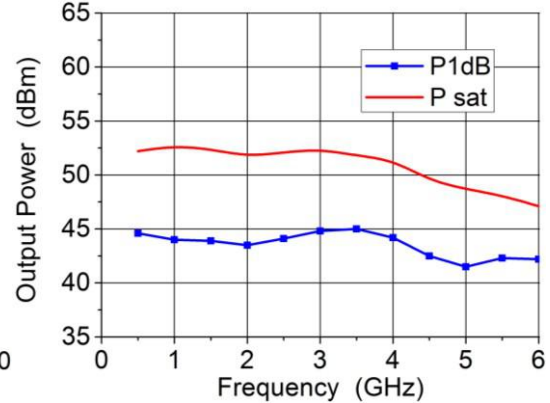

S3871AB Output power VS Frequency

## 2. General information

(1) Environmental requirements:

Working temperature range:  $0^{\circ}\text{C}\sim+40^{\circ}\text{C}$

Storage temperature range:  $-40^{\circ}\text{C}\sim+70^{\circ}\text{C}$

(2) Power conditions: AC  $220\text{V}\pm 10\%$ ,  $50\text{Hz}\pm 5\%$

## 5.2 Indicator Tests

Let's take the indicator testing of S3871FB solid-state power amplifier as an example, which can be used as a reference for other models of solid-state power amplifiers.

### 1. Testing Instruments and Equipment

Major instruments and equipment required as shown in the table below:

SN	Instrument	Main technical indicators
1	Vector network analyzer	Frequency range: 0.5GHz - 40GHz
2	Signal source	Frequency range: 0.5GHz - 40GHz
3	Power meter	Frequency range: 0.5GHz - 40GHz
4	Power sensor	Frequency range: 0.5GHz - 40GHz
5	Spectrum analyzer	Frequency range: 0.5GHz - 40GHz
6	Attenuator	Frequency range: 0.5GHz - 40GHz

Note: Other instruments that can meet the requirements for indicator testing can be used as substitutes.

### 2. Indicator Testing Methods

#### 2.1 Normal functionality inspection

Connect the S3871FB solid-state power amplifier to the power supply, place the power switch on the rear panel to the "-" position (the "On" position), and the standby power indicator on the front panel will be on. When the working switch on the front panel is turned on, the fans on both sides of the rear panel of the housing will rotate, the working indicator near the working switch on the front panel is on, the display on the output power display screen is normal and the key sensitivity is OK.

#### 2.2 Performance characteristics testing

The specific operation steps for testing the following indicators are provided according to the testing instrument shown in the figure. When other testing instruments with the same performance characteristics are used for testing, please refer to the User Manual of such instruments for the specific operation. A signal source and a power meter as shown in Figure 5-2 can also be used to test the gain.

##### (1) Gain test

a) Testing equipment:

- Vector network analyzer: 3672 1
- High-power attenuator: 89-30-21 1
- Calibration cable: 2
- 2.4mm calibration piece: 85056A 1 set

b) Testing diagram

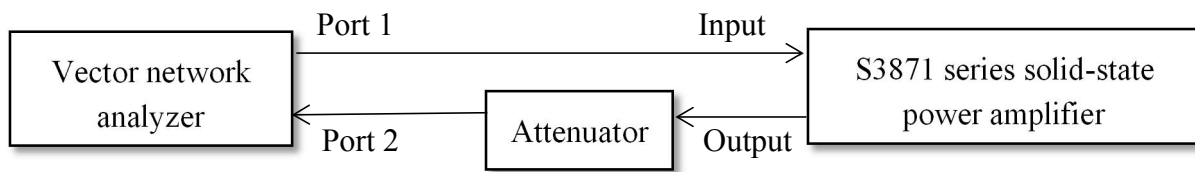

Figure 5-1 Gain and standing wave testing diagram

c) Gain testing steps:

- ① Turn on the power of the amplifier and 3672 for preheating for 30 minutes.
- ② Set 3672 to [Test], [S21], [Format], [Log Amplitude], power of -40dBm, frequency of 32GHz to 40GHz, frequency sweep time of 1s, and number of measurement points of 101.
- ③ Connect the test cable of port 2 of 3672 with the attenuator, and then carry out dual-port calibration of 3672 after connection with the attenuator. The attenuator adopts a high-power fixed attenuator with the attenuation value greater than 30dB, and the continuous wave carrying power must be greater than 10W. The recommended model is 89-30-21 manufactured by Weinschel Company.
- ④ Turn the gain regulator on the front panel of the S3871FB solid-state power amplifier clockwise to the end, conduct the gain test according to the connection system shown in Figure 5-1, and record the value S21 as the gain value of the amplifier.

**(2) Input port voltage standing wave test**

a) Testing equipment:

Vector network analyzer: 3672 1  
 High-power attenuator: 89-30-21 1  
 Calibration cable: 2  
 2.4mm calibration piece: 85056A 1 set

b) Input port standing wave testing steps:

- ① Turn on the power of the amplifier and 3672 for preheating for 30 minutes.
- ② Set 3672 to [Test], [S11], [Format], [SWR], power of -40dBm, frequency of 32 GHz to 40 GHz, frequency sweep time of 1s, and number of measurement points of 101.
- ③ Carry out dual-port calibration of 3672.
- ④ Turn the gain regulator on the front panel of the S3871FB solid-state power amplifier clockwise to the end, conduct the SWR test according to the connection system shown in Figure 5-1, and record the value S21 as the SWR value of the amplifier.

**(3) Max. Output Power, Max. Input Power and Output Power Flatness Tests**

a) Testing equipment:

Signal source:	S1465	1
Power meter:	2434	1
Power sensor:	71712	1
High-power attenuator:	89-30-21	1

b) Testing diagram:

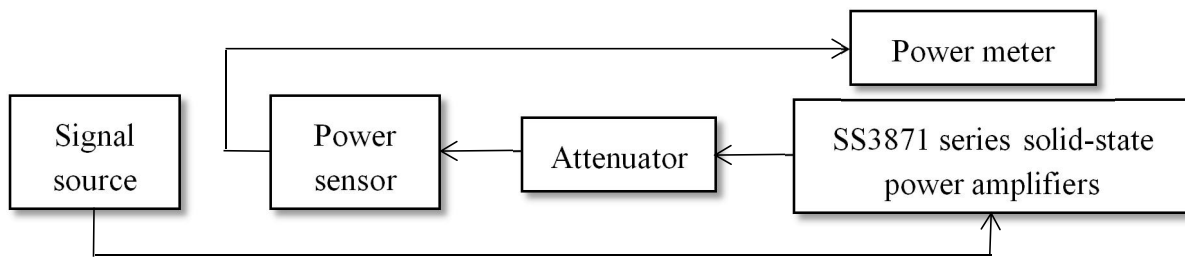

Figure 5-2 Diagram for testing of max. output power, max. input power and output power flatness

c) Testing steps for max. output power, max. input power and output power flatness:

- ① Max. output power test: connect the instrument as shown in Figure 5-2, set the working frequency range of the signal source to 32GHz - 40GHz with the stepping by 0.5GHz, set the output power of the signal source connected to the input port of the amplifier to 0dBm or any other value that can make the amplifier in the working state of saturated output, record the reading on the power meter at each test frequency point, and calculate the sum of the max. output power degree and the attenuation value on the attenuator, which is just the max. output power.
- ② Max. input power test: observe the working state of the amplifier at the max. input power. It is required that the amplifier should be able to work normally without damage at each test frequency point and return to the original working state when it is lower than the max. input power.
- ③ Output power flatness test: place the internal amplitude stabilization key on the rear panel of the instrument to the "Internal Amplitude Stabilization" working state, test and record the output power of the 1dB compression point at each test frequency point, and calculate the average value of the max. and min. output powers. Neither the max. nor the min. output power should exceed the flatness requirement, namely, it should be in the range of 3dB above the average value and 3dB below the average value.

**(4) 1dB Compression Point Output Power Test**

a) Testing equipment:

Signal source:	S1465	1
Power meter:	2434	1
Power sensor:	71712	1

High-power attenuator: 89-30-21 1

b) 1dB compression point output power test steps:

Connect the instrument as shown in Figure 5-2, set the working frequency range of the signal source to 32GHz - 40GHz with the stepping by 0.5GHz, set the output power of the signal source connected to the input port of the amplifier to -30dBm or any other value that can make the amplifier in the working state of linear amplification, increase the output power of the signal source, record the reading on the power meter when the gain is compressed by 1dB, then calculate the sum of this value and the attenuation value on the attenuator, which is just the output power of the 1dB compression point.

### (5) Non-harmonic Suppression Test

a) Testing equipment:

Signal source: S1465 1

Spectrum analyzer: 4036 1

High-power attenuator: 89-30-21 1

b) Testing diagram:

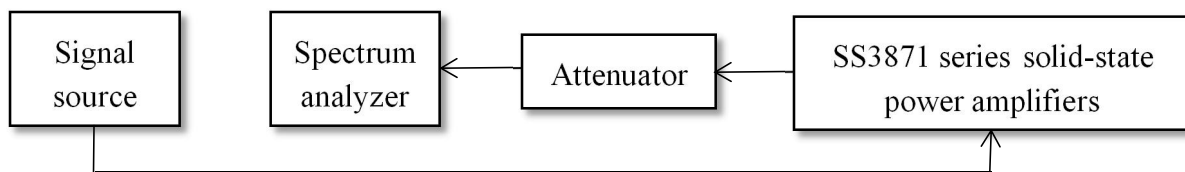

Figure 5-3 Diagram of the non-harmonic suppression test

c) Non-harmonic suppression test steps:

- ① Connect the instrument as shown in Figure 5-3, turn on the power of the signal source, the amplifier and the spectrum analyzer preheating.
- ② Set the operating range of the spectrum analyzer to 30GHz - 50GHz, set the initial operating frequency of the signal source to 32GHz, with the stepping by 1GHz, adjust the amplifier to the 1dB compression point output power state of each operating frequency point in turn according to the test method of 1dB compression point for the output power of the amplifier, and record the difference between the peak value of fundamental wave and the non-harmonic wave of the spectrum analyzer, which should meet the indicator requirements at most operating frequency points.

---

## Chapter 6 Maintenance and Repair

### 6.1 Regular Maintenance

#### 1. Testing and Calibration

S3871 series solid-state power amplifiers should be tested and calibrated regularly on a yearly basis. The testing period should be reduced accordingly if the instruments are working in severe environments.

#### 2. Surface Cleaning

Wipe the front panel and the housing with a cloth dipped in a neutral detergent, and then wipe it with a dry cloth.



Never wipe the instrument with corrosive cleaning agents or chemicals.

---

### 6.2 General Maintenance

#### 1. Finding Faults in Advance

If your S3871 series solid-state power amplifier is malfunctioning, please check whether the problem is caused by the solid-state power amplifier itself first. Before the test, check whether the accessories connected with the solid-state power amplifier and the interfaces between them are normal to ensure that the problem is not caused by incorrect configuration. If the problem is really caused by the power amplifier itself, please contact us by email: [sales@salukitec.com](mailto:sales@salukitec.com).

#### 2. General Faults

- 1) If there is no display on the front panel, check the connection between the housing and the power cable for looseness or dropping. If the connection is normal, but the standby indicator on the front panel is still not on, test whether the power switch is in good contact. If the contact is good, please send the instrument to us for repair.
- 2) If both the power supply and the front panel display are normal, while there's still no amplified output of the power amplifier, or the saturated output power is less than half of the nominal value, please send the instrument back to us for repair.

-END OF DOCUMENT-